

VIA

Amplifiers

User Guide



VIA[®]



Contents

Introduction

About this Manual..... 4

Important Safety Instructions..... 5

Safety Warnings..... 5

Unpacking the Units..... 5

Consignes de Sécurité Importantes..... 6

Avertissement de Sécurité..... 6

Compliance

For Customers in Europe..... 7

For Customers in the USA..... 7

For Customers in Canada..... 8

Product Overview

VIA2004..... 9

VIA2502..... 9

VIA5002..... 9

VIA5004..... 9

Installation

Mechanical Installation..... 10

powerCON Wiring Instructions..... 11

Audio Connections

Input Connections..... 12

Using Unbalanced Connections..... 12

Amplifier Output Connections..... 13

Panel Layouts

VIA2004..... 14

VIA2502..... 15

VIA5002..... 16

VIA5004..... 17

Protection

Turn-on-turn-off Muting..... 18

Short Circuit Protection..... 18

Thermal Protection..... 18

DC Fault Protection..... 18

Input / Output Protection.....	18
Protection Systems.....	18
Operation	
Connect Power to the Amplifier.....	19
Connect All Input and Output Cables.....	19
Gain Controls.....	19
Power the System.....	19
Bridge Mode.....	19
Technical Specifications	
VIA2004.....	20
VIA2502.....	20
VIA5002.....	20
VIA5004.....	20
Current Draw and Thermal Dissipation	
VIA2004.....	21
VIA2502.....	21
VIA5002.....	22
VIA5004.....	22
Technical Drawings	
VIA2004.....	23
VIA2502.....	24
VIA5002.....	25
VIA5004.....	26
Warranty	
Warranty Statement.....	27

Introduction

About this Manual

This user manual gives a detailed description of the features and functions of the Martin Audio VIA amplifiers.

Important Safety Instructions

Please read these instructions and retain for future reference. Heed all warnings and follow all instructions.

- Do not use this apparatus near water. Apparatus shall not be exposed to dripping or splashing and no objects filled with liquids, such as vases, shall be placed on the apparatus.
- Clean only with dry cloth.
- Do not block any ventilation openings. Install in accordance with the manufacturer's instructions.
- Do not install near any heat sources such as radiators, heat registers, stoves or other apparatus (including amplifiers) that produce heat.
- Do not defeat the safety purpose of the polarized or grounding type plug. A polarized plug has two blades with one wider than the other. A grounding type plug has two blades and a third grounding prong. The wide blade or the third prong are provided for your safety. If the provided plug does not fit into your outlet, consult an electrician for replacement of the obsolete outlet.
- Protect the power cable from being walked on or pinched particularly at plugs, convenience receptacles and the point where they exit from the apparatus.
- Only use attachments / accessories specified by the manufacturer.
- Use only with the cart, tripod, bracket or table specified by the manufacturer, or sold with the apparatus. When a cart is used, use caution when moving the cart / apparatus combination to avoid injury from tip-over.
- Unplug this apparatus during lightning storms or when unused for long periods of time.
- Refer all servicing to qualified service personnel. Service is required when the apparatus has been damaged in any way, such as power-supply cable or plug damaged, liquid has been spilled or objects have fallen into the apparatus, this apparatus has been exposed to rain or moisture, does not operate normally, or has been dropped
- This device must not be exposed to drops or splashes of liquid and no object filled with liquids such as a vase, should be placed on the amplifier.
- Permanent disconnection of the mains supply must be achieved by disconnecting the power cable from the rear of the amplifier after the power has been switched off at the mains supply.



DO NOT EXPOSE TO
RAIN OR MOISTURE



NE PAS EXPOSER A LA
PLUIE NI A L'HUMIDITE



Safety Warnings

- Do not remove any covers, loosen any fixings or allow items to enter any aperture.
- The rear of the product may get hot. Avoid direct skin contact during operation and for at least 5 minutes after power has been isolated.
- The product must only be positioned at floor level when operated in a horizontal position.

Unpacking the Units

After unpacking the unit, please check it carefully for any damage. If any is found, immediately notify the carrier concerned – you, the consignee, must instigate any claim. Please retain all packaging in case you need to return the unit.

Please consider the environment. When the product has reached the end of its useful life, please dispose of it responsibly through a recycling centre.

Consignes de Sécurité Importantes

Veillez lire ces instructions et les conserver pour vous y référer ultérieurement. Respectez tous les avertissements et suivez toutes les instructions.

- Ne pas utiliser cet appareil près de l'eau. L'appareil ne doit pas être exposé à des gouttes ou des éclaboussures et aucun objet contenant des liquides, tels que des vases, ne doit être placé sur l'appareil.
- Nettoyer uniquement avec un chiffon sec.
- Ne pas bloquer les ouvertures de ventilation. Installer conformément aux instructions du fabricant.
- Ne pas installer près de sources de chaleur telles que radiateurs, registres de chaleur, poêles ou autres appareils (y compris les amplificateurs) qui produisent de la chaleur.
- Ne supprimez pas le dispositif de sécurité de la fiche polarisée ou mise à la terre. Une fiche polarisée possède deux lames dont l'une est plus large que l'autre. Une prise de terre a eu deux lames et une troisième broche de terre. La lame large ou la troisième broche sont fournies pour votre sécurité. Si la fiche fournie ne rentre pas dans votre prise, consultez un électricien pour remplacer la prise obsolète.
- Protéger le cordon d'alimentation soit écrasé ou pincé, particulièrement au niveau des fiches, des prises et le point où ils sortent de l'appareil.
- Utilisez uniquement les accessoires spécifiés par le fabricant.
- Utilisez uniquement le chariot, le trépied, le support ou la table spécifiés par le fabricant, ou vendu avec l'appareil. Quand un chariot est utilisé, soyez prudent lorsque vous déplacez l'ensemble chariot / appareil afin d'éviter toute blessure en cas de chute.
- Débranchez cet appareil pendant les orages ou lorsqu'il n'est pas utilisé pendant de longues périodes de temps.
- Adressez-vous à un personnel qualifié. Une réparation est requise lorsque l'appareil a été endommagé de quelque façon que ce soit le cordon d'alimentation ou la fiche endommagé, du liquide a été renversé ou des objets sont tombés dans l'appareil, cet appareil a été exposé à la pluie ou à l'humidité, ne fonctionne pas normalement, ou s'il est tombé.
- Le dispositif ne doit pas être exposé à des gouttes ou des éclaboussures et aucun objet rempli de liquides, tels que des vases, doit être placé sur l'appareil.
- Déconnexion permanente de l'alimentation secteur doit être atteint en supprimant le connecteur du cordon fourni à l'arrière de l'unité. Ce connecteur doit être facilement utilisable.



Avertissement de Sécurité

- Ne retirez pas les couvercles, ne desserrez pas les fixations et ne laissez aucune pièce s'introduire dans les ouvertures.
- Le radiateur arrière de cet appareil devient chaud. Evitez tout contact direct avec la peau pendant le fonctionnement et au moins 5 minutes après la mise hors tension de l'appareil.
- Le produit ne doit être positionné au niveau du sol lorsqu'il est utilisé en position horizontale.

Compliance

For Customers in Europe

This product complies with both the LVD (electrical safety) 73/23/EEC and EMC (electromagnetic compatibility) 89/336/EEC directives issued by the commission of the European community.

Compliance with these directives implies conformity with the following European standards:

- EN60065 product safety
- EN55032 EMC emissions
- EN55103-2 EMC immunity

This product is intended for the following electromagnetic environments: E1, E2, E3 & E4.

THIS PRODUCT MUST BE EARTHED. Use only a flexible cable or cord with a green and yellow core which must be connected to the protective earthing terminal of a suitable mains plug or the earthing terminal of the installation. The cord must be a maximum of 2m long, have a 2.5mm² CSA, a 300/500V rating and comply with EN50525-2-11 / H05W-F.

THIS PRODUCT IS DESIGNED FOR PERMANENT INSTALLATION. It must be fitted in to a 19" rack enclosure and not operated unless so installed. The rack enclosure should be open at the front and back to allow free ventilation and movement of air through the product.

For Customers in the USA

This product complies with UL60065 8th edition.

THIS PRODUCT MUST BE EARTHED. Use only a flexible cable or cord with a green or green / yellow core which must be connected to the protective earthing terminal of a suitable mains plug or the earthing terminal of the installation. The cord must be a maximum of 6' long, be 14AWG, have a rating SJ, SJT, SJE or 300/500V H05W-F and be marked VW-1.

THIS PRODUCT IS DESIGNED FOR PERMANENT INSTALLATION. It must be fitted in to a 19" rack enclosure and not operated unless so installed. The rack enclosure should be open at the front and back to allow free ventilation and movement of air through the product.

DECLARATION OF CONFORMITY WITH FCC RULES

We, Martin Audio Ltd. of Century Point, Halifax Road, Cressex Business Park, High Wycombe, HP12 3SL, England, declare under our sole responsibility that this family of devices, complies with Part 15 of the FCC Rules. Operation is subject to the following two conditions: (1) this device may not cause harmful interference, and (2) this device must accept any interference received, including interference that may cause undesired operation.

FEDERAL COMMUNICATIONS COMMISSION NOTICE

An example of this equipment has been tested and found to comply with the limits for a Class A digital device, pursuant to Part 15 of the FCC Rules. These limits are designed to provide reasonable protection against harmful interference in a residential and commercial installation.

This equipment generates, uses, and can radiate radio frequency energy, and if not installed and used in accordance with the instructions, may cause harmful interference to radio communications. However, there is no guarantee that interference will not occur in a particular installation. If this equipment does cause harmful interference to radio or television reception, which can be determined by turning the equipment off and on, the user is encouraged to try and correct the interference by one or more of the following measures:

- Reorient or relocate the receiving antenna.
- Increase the distance between the equipment and the receiver.
- Connect the equipment to an outlet on a circuit different from that to which the receiver is connected.
- Consult the dealer or an experienced radio/TV technician for help.

FCC Caution: Any changes or modifications not expressly approved by the party responsible for compliance could void the user's authority to operate this equipment.

For Customers in Canada

This product complies with CA /CSA C22.2 No.60065-03

Ce produit est conforme avec CA /CSA-C22.2# 60065:2016 Ed.2

THIS PRODUCT MUST BE EARTHED. Use only a flexible cable or cord with a green or green / yellow core which must be connected to the protective earthing terminal of a suitable mains plug or the earthing terminal of the installation. The cord must be a maximum of 6' long, be 14AWG, have a rating SJ, SJT, SJE or 300/500V H05W-F and be marked VW-1.

CE PRODUIT DOIT ÊTRE MIS À LA TERRE. Utilisez uniquement un câble souple avec un noyau vert ou vert / jaune qui doit être relié à la borne de terre de connecteur d'alimentation ou la borne de terre de l'installation. Le cordon doit être un maximum de 6' (2m) de long, 14 AWG (2.5mm² CSA), être classé SJ, SJT, SJE ou 300/500V H05W-F et être marquée VW-1

THIS PRODUCT IS DESIGNED FOR PERMANENT INSTALLATION. It must be fitted in to a 19" rack enclosure and not operated unless so installed. The rack enclosure should be open at the front and back to allow free ventilation and movement of air through the product.

CE PRODUIT EST CONÇU POUR UNE INSTALLATION PERMANENTE. Il doit être installé dans un boîtier rack 19". Le rack devrait être ouvert à l'avant et l'arrière pour permettre la ventilation et le mouvement d'air libre à travers le produit.

DECLARATION OF CONFORMITY WITH CANADIAN ICES-003

This Class A digital apparatus complies with Canadian ICES-003.

Cet appareil numérique de la classe A est conforme à la norme NMB-003 du Canada.

Product Overview



VIA2004

VIA2004 is an advanced 4-channel power amplifier which delivers superb audio performance in a lightweight, cost-effective package. Delivering 4x500 watts into 4 ohms, it is ideal for powering O-Line, ADORN and CDD Series installations in bars, auditoriums and HoW, as well as small-medium scale portable sound reinforcement and club use.

VIA2502

VIA2502 is an advanced 2-channel power amplifier which combines high power density with superb audio performance in a lightweight, cost-effective package. Delivering 2x1250 watts into 2 ohms, or 1x2500 watts into 4 ohms bridged, it is ideal for powering BlacklineX, CDD and V.Series systems in small to medium-scale installations and portable sound applications.

VIA5002

VIA5002 is an advanced 2-channel power amplifier which combines high power density with superb audio performance in a lightweight, cost-effective package. Delivering 2 x 2500 watts into 4 ohms or 2 x 1500 watts into 8 ohms, it ideal for powering subwoofers in installations and portable sound systems.

VIA5004

VIA5004 is an advanced 4-channel power amplifier which combines high power density with superb audio performance in a lightweight, cost-effective package. Delivering 4 x 1250 watts into 2 ohms, or 2 x 2500 watts into 4 ohms bridged, it is ideal for powering Blackline X, CDD and V.Series systems in small to medium-scale installations and portable sound applications. It can also be configured for 3-channel operation, for perfect compatibility with TH Series 3-way systems.

Installation

Mechanical Installation

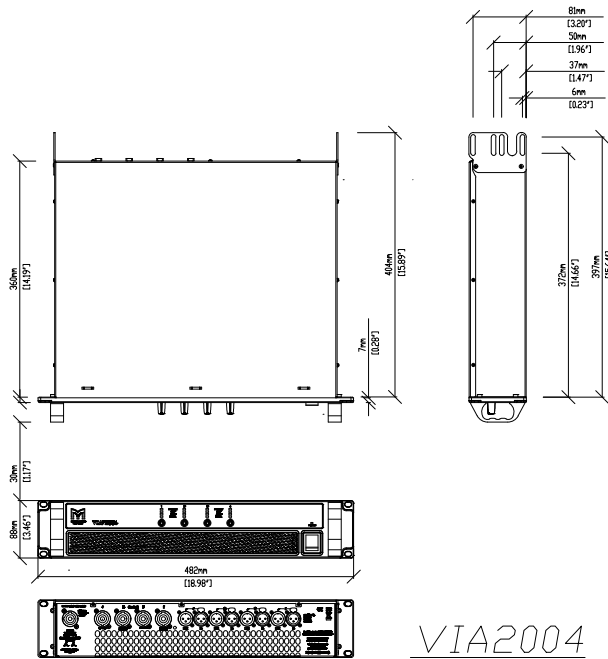

The VIA Series amplifiers are designed to be mounted in a standard 19" rack enclosure. All models have identical mechanical dimensions.

Where the amplifier is used in a fixed installation, as long as the bottom unit is supported and there are no gaps between units, it is acceptable to use only the front panel 19" rack holes when fitting it in a standard rack enclosure. If the amplifier is mounted in a mobile rack it is important that the rear is supported with a rear rack mounting kit (part number IKRACK). Damage caused by insufficient support is not covered by the warranty.

To prevent damage to the front panel it is recommended that plastic cups or washers are fitted underneath the rack mounting bolt heads.

It is possible to mount multiple VIA amplifiers without ventilation gaps between them but it is essential that an unobstructed flow of clean air is available from the front of the unit to the rear. It is important that neither the air intakes on the front of the unit or the exhaust vents at the rear are covered. Steps must be taken to ensure that hot air does not continually circulate through the amplifiers from the back of the rack to the front.

The amplifier should never be exposed to rain or moisture during operation or storage. If the unit does come into contact with moisture, remove the AC power cable immediately and leave it in a dry and warm location to dry out.

Note that when any equipment is taken from a cold location into a hot humid one, condensation may occur inside the device. Always allow time for the equipment to attain the same temperature as its surrounding environment before connecting the AC power cable.

IMPORTANT

It is the responsibility of the user to ensure that dirt, liquids and vapour from oil-based theatrical smoke, haze or fog machines is not ingested by the amplifier. Damage so caused is not covered by the manufacturer's warranty.

AC power connection

The amplifier utilises a Neutrik powerCON type locking AC power connector. Use only an AC power cable with a correctly terminated powerCON type connector to make the connection to the mains power supply. These connectors operate in identical fashion to a Neutrik Speakon loudspeaker connector (but are uniquely keyed making it impossible to insert a mains plug into a loudspeaker socket and vice versa). Insert the plug with the latch at approximately -45° from the vertical (the 10.00pm position), rotate the connector clockwise until you hear a 'click' indicating that the latch has operated. Check that the connector is secure. To remove, grip the connect and pull back the latch with your thumb, rotate the connector anticlockwise and pull to remove.

The amplifiers are designed to operate on 50/60 Hz AC power. The power supply sections automatically configure themselves for either 100V or 230V nominal voltage at turn on. The amplifiers will operate over an extended range of supply voltages (please refer to the technical specifications).

Note that whilst the amplifier will operate correctly at voltages indicated, the specified output power will only be achieved when operating with the stated nominal voltages.

IMPORTANT SAFETY INSTRUCTION

The powerCON system is certified as connector without breaking capacity according IEC 61984 / VDE 0627.

In this standard the term connector (without breaking capacity) refers to components which in normal use are not to be engaged or disengaged when under load or live.

powerCON Wiring Instructions

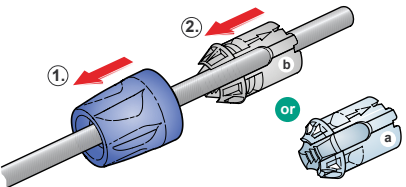
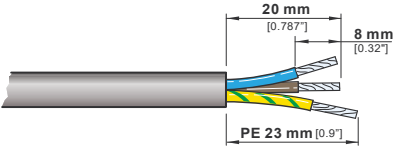
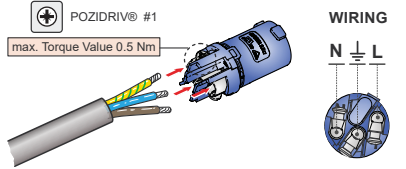
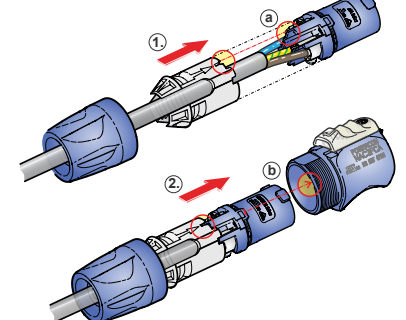
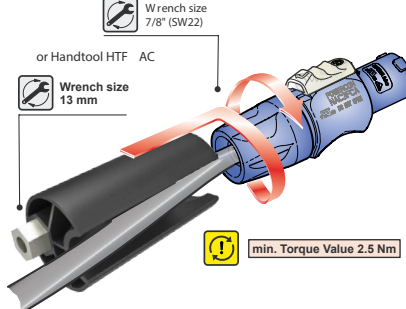
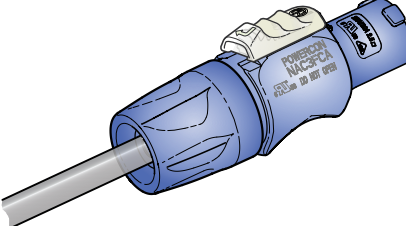
<p>Place the bushing (1) and the chuck (2) over the cable:</p> <p>White chuck (a): 6.0 – w11.0mm (0.236 – 0.433")</p> <p>Black chuck (b): 9.5 – 15.0mm (0.374 – 0.59")</p> <p>VDE: 9.5 – 14.0mm (0.374 – 0.551")</p>	
<p>Prepare the cable as shown:</p> <p>Cable O.D: 6.0 – 15.0mm (0.236 – 0.59")</p> <p>Wire size: 2.5mm² (AWG 14)</p>	
<p>Prepare the cable as shown:</p> <p>Cable O.D: 6.0 – 15.0mm (0.236 – 0.59")</p> <p>Wire size: 2.5mm² (AWG 14)</p>	
<p>Slide the insert and the chuck (1) into the housing (2).</p> <p>IMPORTANT:</p> <ul style="list-style-type: none"> Align the chuck by positioning the nose into the recess. Pay attention to the guiding keyway. 	
<p>Fasten bushing by means of a fork wrench 7/8" (SW 22) min. Torque 2.5 Nm (1.8 lb-ft).</p> <p>OPTION: Use the Neutrik handtool Art. No. HTFAC to tighten the bushing.</p>	
<p>Finished powerCON</p>	

Audio Connections

Input Connections

For each input channel there is a female XLR connector for analogue inputs. The HOT, + or 'in phase' connection should be made to pin 2 of the XLR connector.

The COLD, - or 'out of phase' connection should be made to pin 3 of the XLR connector.

Pin 1 of the XLR connectors is internally connected to the chassis. The shield of the input cable should always be connected pin 1 of the XLR to ensure that EMC performance and regulations are met.

Input XLR Balanced connection

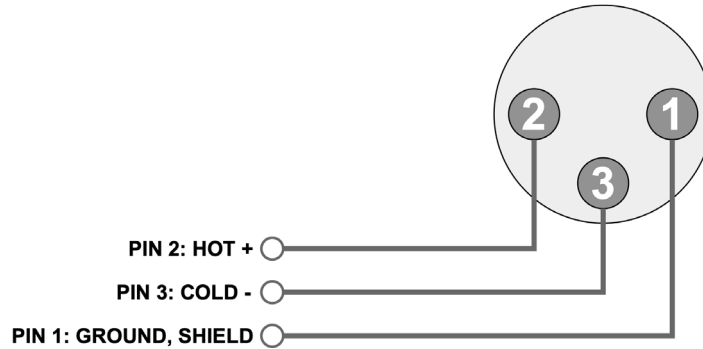

Using Unbalanced Connections

Please note that the use of unbalanced connections is not recommended, however when connecting the amplifier to an unbalanced audio source, the signal conductor should be connected to XLR pin2. The 'Cold' conductor or cable screen should be connected to XLR pin 1 with a short connection made between pin 1 and pin 3.

Input XLR Unbalanced connection

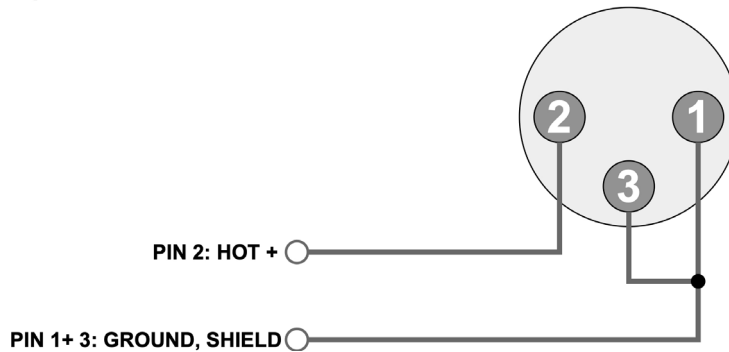

Amplifier Output Connections

The VIA amplifiers are fitted with one Speakon™ connector per amplifier channel. The appropriate conductor terminations are shown below and on the rear panel of the unit.

Amplifier output connections – channels 2 & 4

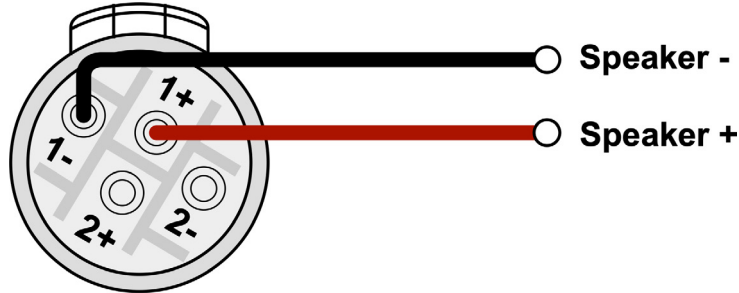

Additionally, channel 2 output is duplicated on the Speakon™ connector for amplifier channel 1 for bi-amp wiring. Similarly, the channel 4 output is duplicated on the Speakon™ connector for amplifier channel 3 on four channel models. This can be useful for making a connection to two loudspeakers with one 4-core cable (i.e. bi-amp).

Amplifier output connections – outputs 1 and 3

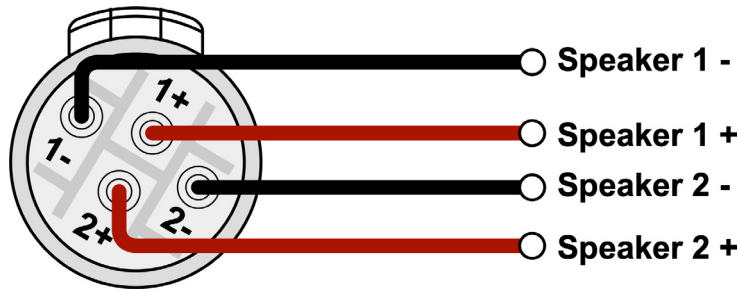

In addition, the channel 1 or channel 3 connector can also be used if the pair of amplifier channels is being operated in bridged mode.

Amplifier output connections – bridge VIA2502 and VIA5004 only

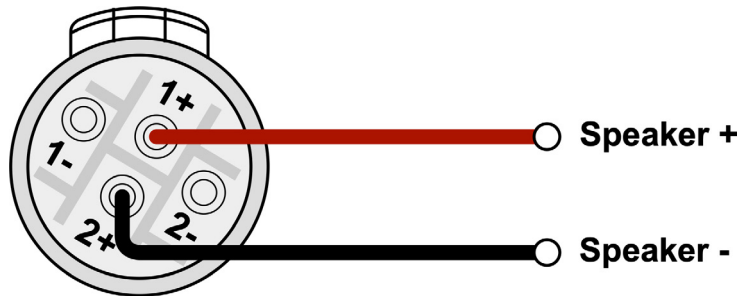

More than one speaker can be connected to each channel provided the total impedance per channel is not less than 2 ohms for the VIA 2502 and VIA5004, or 4 ohms for the VIA5002 and VIA2004. In bridged mode for the VIA2502 and VIA5004 the minimum total impedance should not be less than 4 ohms.

Panel Layouts

VIA2004

Front panel

1. Gain control – Continuous adjustment from 0dB attenuation (32dB of gain) to zero (-∞) input.
2. Signal indicators – Two indicators show “Sig” and “-6dB” for all inputs. The signal present Indicators operate at approximately -40dBu.
3. Clip indicator – The Clip indicators warn the user of input overload and operate at 1dB before clip.
4. Protect indicator – The VIA amplifiers have sophisticated protection and monitoring systems which keep the amplifier within its safe operating window whenever possible. This indicator lights when the protection systems are active in any way.
5. Power indicator – The Power Switch is associated with a POWER indicator. This red indicator is lit when power is applied, and the power switch is in the ON position.
6. Power switch – Applies mains power to the device.

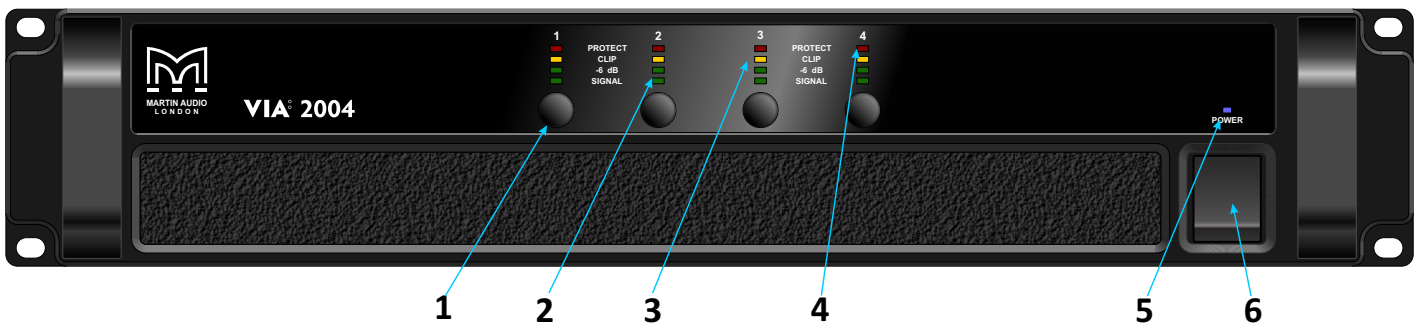

Rear panel

1. Power inlet – The unit should be connected to a suitable mains electricity supply using an earthed Neutrik powerCON connection power lead. The device has a switch mode power supply that is capable of operating with a nominal mains voltage of 100V to 230V, 50/60Hz without re-configuration.
2. Loudspeaker connectors – The amplifier Neutrik speakON outputs. Connect the loudspeaker to the 1+ and 1- terminals. CH1 also carries the (duplicated) loudspeaker output for channel 2 on terminals 2+ and 2-. CH3 also carries the (duplicated) loudspeaker output for channel 4 on terminals 2+ and 2-.
3. Analogue audio input connectors – All audio connections are fully balanced and wired: pin-1 to ground (as required by the AES48 standard), pin-2 hot & pin-3 cold.
4. Analogue audio link connectors – Carries a duplicate (parallel) connection from that channel (to link to another amplifier for example).

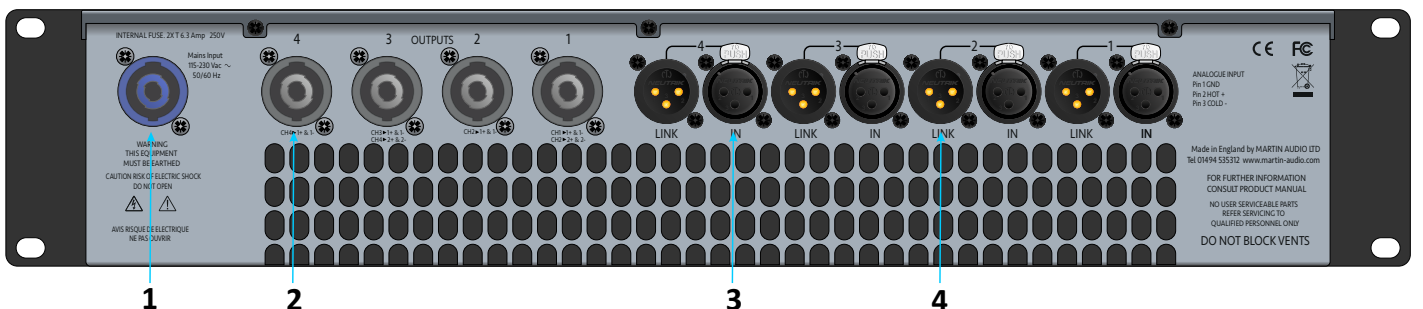

VIA2502

Front panel

1. Input signal indicators – Two indicators show “Sig” and “-6dB” for all inputs. The signal present indicators operate at approximately -40dBu.
2. Gain control – Continuous adjustment from 0dB (32dB of gain) to zero (-∞).
3. Bridge mode indicator – This will illuminate when the channel pair is in bridge mode. The controls for the left channel of the pair will determine the settings. See bridge mode.
4. Clip indicator – The clip indicators warn the user of input overload and operate at 1dB before clip.
5. Protect indicator – The VIA amplifiers have sophisticated protection and monitoring systems which keep the amplifier within its safe operating window whenever possible. This indicator lights when the protection systems are active in any way.
6. Power indicator – The power switch is associated with a POWER indicator. This red indicator is lit when power is applied, and the power switch is in the ON position.
7. Power switch – Applies mains power to the device.

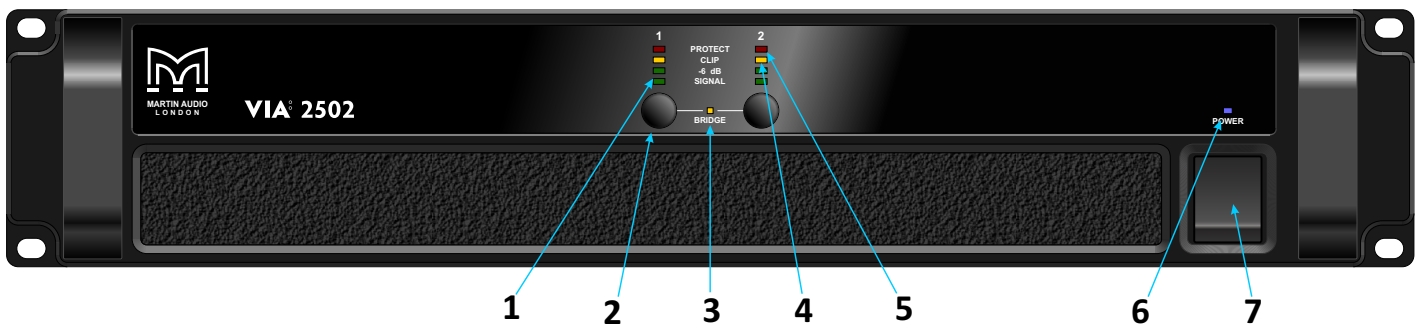

Rear panel

1. Power inlet – The unit should be connected to a suitable mains electricity supply using an earthed Neutrik powerCON connection power lead. The device has a switch mode power supply that is capable of operating with a nominal mains voltage of 100V to 230V, 50/60Hz without re-configuration.
2. Loudspeaker connectors – The amplifier Neutrik speakON outputs. Connect the loudspeaker to the 1+ and 1- terminals. CH1 also carries the (duplicated) loudspeaker output for channel 2 on terminals 2+ and 2-.
3. Analogue audio link connectors – Carries a duplicate (parallel) connection from that channel (to link to another amplifier for example).
4. Bridge switch - Switches the amplifier to operate in bridge mode.
5. Analogue audio input connectors – All audio connections are fully balanced and wired: pin-1 to ground (as required by the AES48 standard), pin-2 hot & pin-3 cold.

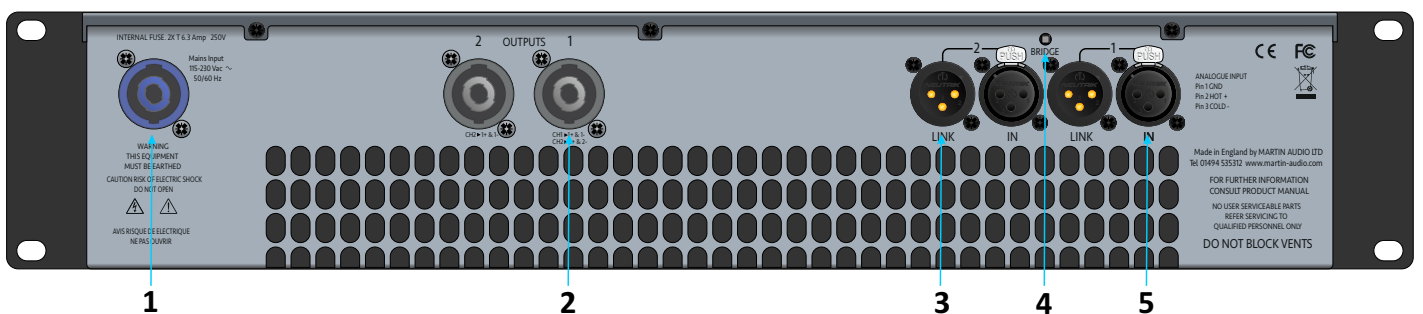

VIA5002

Front panel

1. Gain control – Continuous adjustment from 0dB attenuation (32dB of gain) to zero ($-\infty$) input.
2. Signal indicators – Two indicators show “Sig” and “-6dB” for all inputs. The signal present Indicators operate at approximately -40dBu.
3. Clip indicator – The clip indicators warn the user of input overload and operate at 1dB before clip.
4. Protect indicator – The VIA amplifiers have sophisticated protection and monitoring systems which keep the amplifier within its safe operating window whenever possible. This indicator lights when the protection systems are active in any way.
5. Power indicator – The power switch is associated with a POWER indicator. This red indicator is lit when power is applied, and the power switch is in the ON position.
6. Power switch – Applies mains power to the device.

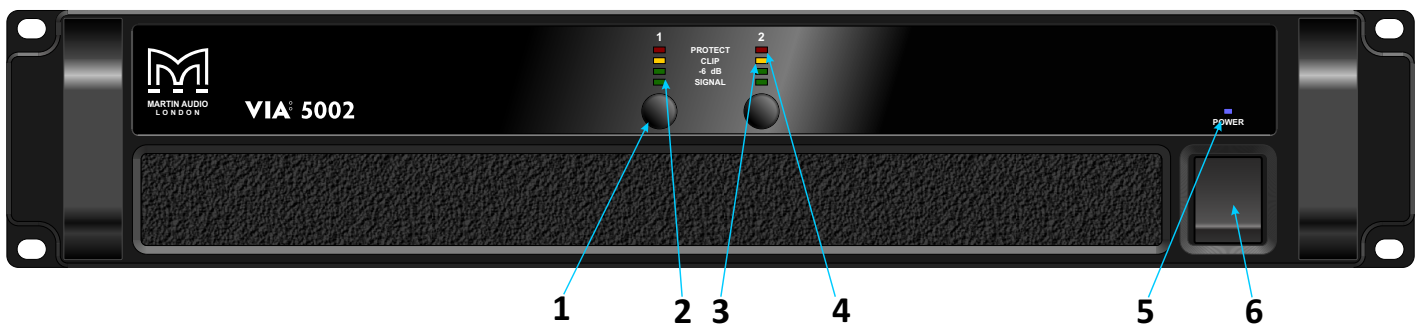

Rear panel

1. Power inlet – The unit should be connected to a suitable mains electricity supply using an earthed Neutrik powerCON connection power lead. The device has a switch mode power supply that is capable of operating with a nominal mains voltage of 100V to 230V, 50/60Hz without re-configuration.
2. Loudspeaker connectors – The amplifier Neutrik speakON outputs. Connect the loudspeaker to the 1+ and 1- terminals. CH1 also carries the (duplicated) loudspeaker output for channel 2 on terminals 2+ and 2-.
3. Analogue audio link connectors – Carries a duplicate (parallel) connection from that channel (to link to another amplifier for example).
4. Analogue audio input connectors – All audio connections are fully balanced and wired: pin-1 to ground (as required by the AES48 standard), pin-2 hot & pin-3 cold.

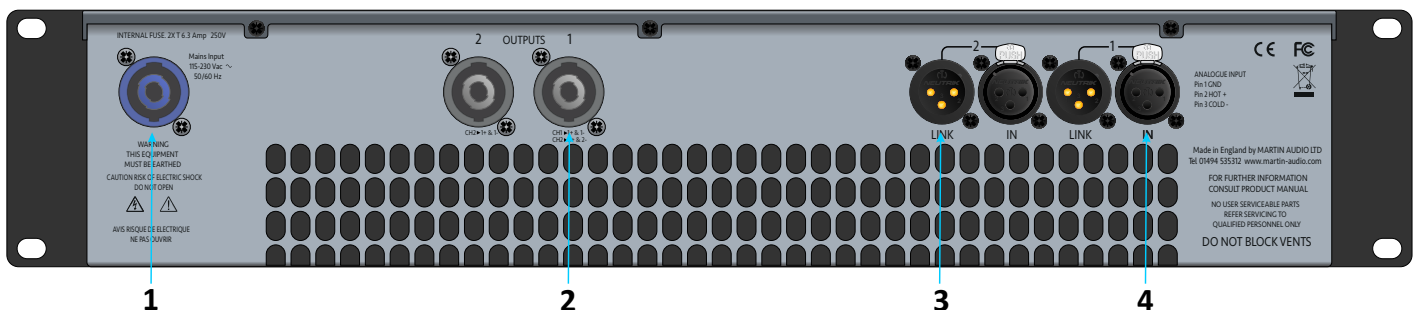

VIA5004

Front panel

1. Input signal indicators – Two indicators show “Sig” and “-6dB” for all inputs. The signal present Indicators operate at approximately -40dBu.
2. Gain control – Continuous adjustment from 0dB (32dB of gain) to zero (-∞).
3. Bridge mode indicator – This will illuminate when the channel pair is in bridge mode. The controls for the left channel of the pair will determine the settings. See bridge mode.
4. Clip indicator – The clip indicators warn the user of input overload and operate at 1dB before clip.
5. Protect indicator – The VIA amplifiers have sophisticated protection and monitoring systems which keep the amplifier within its safe operating window whenever possible. This indicator lights when the protection systems are active in any way.
6. Power indicator – The power switch is associated with a POWER indicator. This red indicator is lit when power is applied, and the power switch is in the ON position.
7. Power switch – Applies mains power to the device.

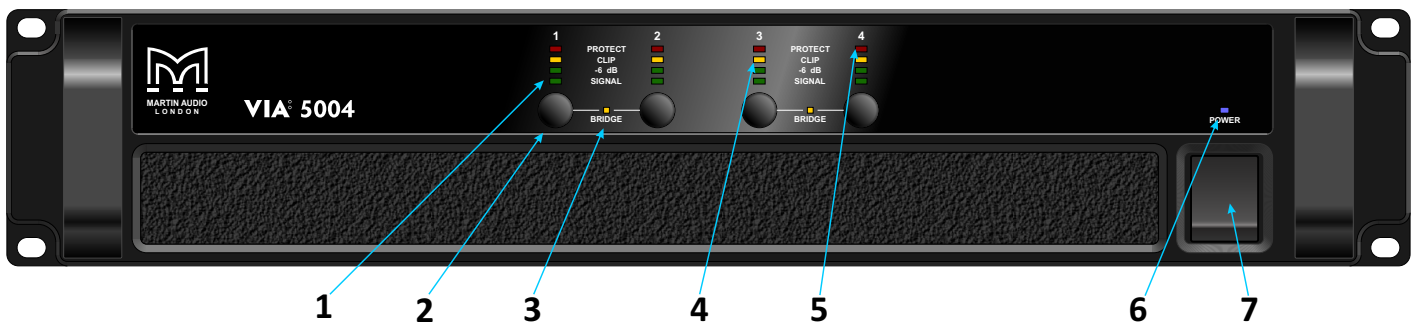

Rear panel

1. Power inlet – The unit should be connected to a suitable mains electricity supply using an earthed Neutrik powerCON connection power lead. The device has a switch mode power supply that is capable of operating with a nominal mains voltage of 100V to 230V, 50/60Hz without re-configuration.
2. Loudspeaker connectors – The amplifier Neutrik speakON outputs. Connect the loudspeaker to the 1+ and 1- terminals. CH1 also carries the (duplicated) loudspeaker output for channel 2 on terminals 2+ and 2-. CH3 also carries the (duplicated) loudspeaker output for channel 4 on terminals 2+ and 2-.
3. Analogue audio input connectors – All audio connections are fully balanced and wired: pin-1 to ground (as required by the AES48 standard), pin-2 hot & pin-3 cold.
4. Analogue audio link connectors – Carries a duplicate (parallel) connection from that channel (to link to another amplifier for example).
5. Bridge switch – Switches the amplifier to operate in bridge mode.

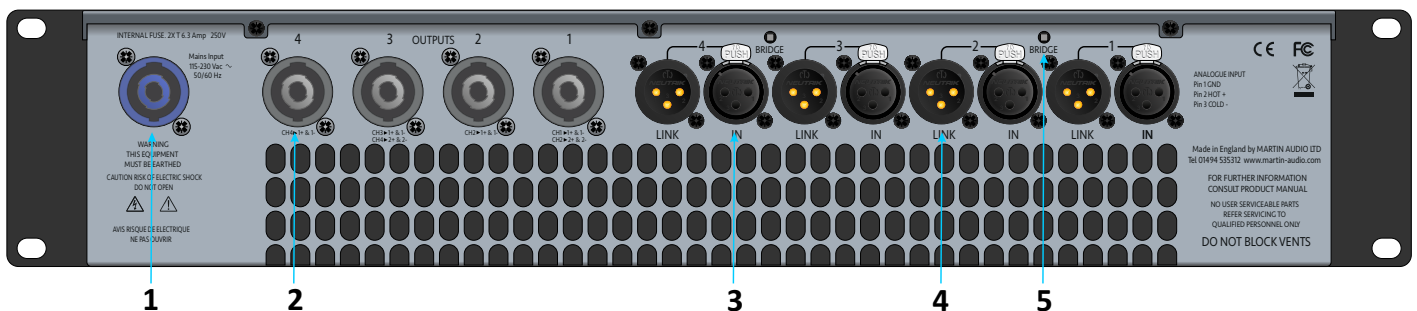

Protection

Turn-on-turn-off Muting

For about four seconds after turn-on, and immediately at turn-off, the amplifier outputs are muted.

Short Circuit Protection

A short circuit protection system safeguards the amplifier's output devices under short circuits and other stressful loads. It is completely inaudible when inactive. In the event of a short circuit condition, the red Protect LED will be illuminated. The amplifier protection has an auto reset mode which will attempt to reset the amplifier for normal use after 2 seconds. If the short circuit is still present the amplifier will attempt to reset every 2 seconds until the short is removed.

Thermal Protection

The VIA amplifiers use a continuously variable speed fan to assist cooling (the fan speed changes in response to the amplifier's cooling requirements). If the heatsink temperature reaches above 85°C the thermal sensing circuitry will operate the protect circuitry and mute each channels power section. Once the heatsink has cooled below 85°C the amplifier will automatically come out of protect mode

DC Fault Protection

If DC or excessive subsonic energy appears at a channel output, an instantaneous protection circuit will mute all channels of the amplifier.

Input / Output Protection

An ultrasonic network decouples RF from the outputs and keeps the amplifier stable with reactive loads.

Protection Systems

Comprehensive protection features preserve the longevity of the loudspeaker and amplifier by continuously monitoring several critical parameters, and reducing the gain, or muting the amplifier either temporarily or permanently depending on the nature and seriousness of the fault or misuse. The amplifier will recover and restart if at all possible but may remain in shut down if a serious fault persists.

Limiters deal with routine over-driving of the amplifier, making sure that the driver(s) are not pushed too hard. The limiter indicator(s) will warn you when the driver is being driven into limit.

Minor faults are dealt with by 'dimming' the amplifier, reducing the level to a sufficient degree and for a sufficient time that the amplifier is able to recover gracefully without any user interaction. When the fault condition has passed, the amplifier will recover automatically.

More serious faults may cause the amplifier to mute while it recovers, after which it will automatically re-energise, again without user interaction. If such a fault is found to be persistent however, the amplifier is shut down permanently. A power cycle by the user is then required.

Operation

Connect Power to the Amplifier

Connect a power source to the amplifier using a Neutrik powerCON cable but do not switch the amplifier on until all input and output connections have been made. The amplifier in a system should always be the last device turned on and the first device turned off when shutting a system down.

Connect All Input and Output Cables

All speaker connections should be made with high quality speaker cable with a minimum cross-sectional area of 2.5mm². For longer runs the conductor area should be increased to 4mm² or 6mm² for very long runs (up to 100m). The amplifier outputs are on Neutrik speakON connectors, the other end of the speaker cable should have a connector to match the speaker. For installation products such as Martin Audio ADORN or CDD, the cable can be left with bare ends. Ideally tin these or use crimped bootlace ferrules to prevent stray strands accidentally shorting the amplifier. The vast majority of portable loudspeakers also use Neutrik speakON so a speakON to speakON cable can be used.

Input cables should be balanced XLR using 3-core cable with a shield. Most signal processing and mixing products also use XLR connections, so the cable can be a male to female XLR or microphone cable.

Gain Controls

In many cases where the system is familiar the gain controls can be left all the way up (fully clockwise). If there is any possibility of noise upstream of the amplifier it is advisable to turn the gain controls all the way down before powering the amplifier. The level can then be carefully turned back up to make sure that the system is clear of unwanted noises. This will ensure no sudden loud bursts of noise. In normal use the gain control should be used turned full up so that the amplifier gain is 32dB as specified (38dB for amplifiers run in bridge mode). If the amplifier is being used in a system with several bands; sub, low and high frequency for example, the relative levels of each band should be adjusted within the system processor NOT by using the amplifier gains. System processor limiter settings depend on knowing the gain of the amplifier and the VIA amplifiers will only operate with a gain of 32dB as published with the gain control up fully clockwise.

Power the System

Turn all devices in the system on starting at the start of the signal chain and ending with the amplifier. If the gain controls on the amplifier were turned down as a safety measure as mentioned above, they should now be turned fully up.

The system is now ready for use. You can use the amplifier gain controls as a temporary mute if required by turning them all the way down fully anticlockwise.

Bridge Mode

The VIA2502 and VIA5004 allow bridge operation which uses two channels to give double the power into a single load. In this mode, only one set of controls is active per pair of amplifier channels since both of the amplifiers in the pair are driven with the same signals, as determined by the left-hand (lower numbered) channel of the pair controls. Bridge mode is enabled or disabled using the recessed switch on the rear panel for a given odd numbered output. When enabled, the bridge indicator will be illuminated between the bridged channels on the amplifier front panel. Note that the gain of a bridged pair of channels will be 6dB higher than a single channel so 38dB. This may impact on limiter settings and balance of levels in a system where some amplifier channels are bridged and others are in standard mode.

Technical Specifications

VIA2004

General	
TYPE	Four-channel Class D amplifier
POWER OUTPUT*	4 x 500W into 4 ohms 4 x 250W into 8 ohms
COOLING	
Vari-speed fans, front-to-back airflow	
MAXIMUM AMBIENT TEMPERATURE	40°C (105°F)
Audio Inputs/Outputs	
ANALOGUE IN/LINK (4 CHANNELS)	4 x female, 4 x male Neutrik™ XLR
ANALOGUE INPUT IMPEDANCE	5 kΩ typical, balanced
MAXIMUM ANALOGUE INPUT LEVEL	+20dBu
AMPLIFIER OUTPUTS	4 x Neutrik Speakon™ NL4
Audio Performance	
FREQUENCY RESPONSE	20Hz - 20kHz +/- 0.45dB, 4 ohm load
TOTAL HARMONIC DISTORTION	0.003% typical, 1kHz @ 1W
Power Supplies	
TYPE	2 x high current, high frequency switch-mode
AC INPUT OPERATING RANGE	100-240V +/-10% 45 - 65Hz
MAINS CONNECTOR	1 x Neutrik Powercon™
TOTAL SYSTEM EFFICIENCY	89% (4 x 250W into 8 ohms)
Physical	
DIMENSIONS	(W) 482 x (H) 2U/88mm x (D) 441mm (W) 19in x (H) 2U/3.5in x (D) 17.4in incl handles and optional rear support
WEIGHT	8kg (17.6lbs)

VIA5002

General	
TYPE	Two-channel Class D amplifier
POWER OUTPUT*	2 x 2500W into 4 ohms 2 x 1600W into 8 ohms
COOLING	
Vari-speed fans, front-to-back airflow	
MAXIMUM AMBIENT TEMPERATURE	40°C (105°F)
Audio Inputs/Outputs	
ANALOGUE IN/LINK (4 CHANNELS)	2 x female, 2 x male Neutrik™ XLR
ANALOGUE INPUT IMPEDANCE	10KΩ balanced
MAXIMUM ANALOGUE INPUT LEVEL	+20dBu
AMPLIFIER OUTPUTS	2 x Neutrik Speakon™ NL4
Audio Performance	
OUTPUT NOISE	-113dBA, referenced to max output (22kHz bandwidth)
FREQUENCY RESPONSE	<10Hz - >20kHz +/- 0.25dB
TOTAL HARMONIC DISTORTION	<0.05% typical @ 1kHz, -3dB output (22kHz bandwidth)
SLEW RATE	>80V per microsecond
DAMPING FACTOR	120 ref 8 ohms
Power Supplies	
TYPE	2 x high current, high frequency switch-mode
AC INPUT OPERATING RANGE	100-240V +/-10% 45 - 65Hz
TOTAL SYSTEM EFFICIENCY	>90% typical
MAINS CONNECTOR	1 x Neutrik Powercon™
Physical	
DIMENSIONS	(W) 482 x (H) 2U/88mm x (D) 441mm (W) 19in x (H) 2U/3.5in x (D) 17.4in incl handles and optional rear support
WEIGHT	10kg (22lbs)

VIA2502

General	
TYPE	Two-channel Class D amplifier
POWER OUTPUT*	2 x 1250W into 2 ohms 2 x 800W into 4 ohms 2 x 450W into 8 ohms 1 x 2500W bridged into 4 ohms
COOLING	
Vari-speed fans, front-to-back airflow	
MAXIMUM AMBIENT TEMPERATURE	40°C (105°F)
Audio Inputs/Outputs	
ANALOGUE IN/LINK (4 CHANNELS)	2 x female, 2 x male Neutrik™ XLR
ANALOGUE INPUT IMPEDANCE	10kΩ Balanced
MAXIMUM ANALOGUE INPUT LEVEL	+20dBu
AMPLIFIER OUTPUTS	2 x Neutrik Speakon™ NL4
Audio Performance	
OUTPUT NOISE	-113dBA, referenced to max output (22kHz bandwidth)
FREQUENCY RESPONSE	<10Hz - >20kHz +/- 0.25dB
TOTAL HARMONIC DISTORTION	<0.05% typical @ 1kHz, -3dB output (22kHz bandwidth)
SLEW RATE	>80V per microsecond
DAMPING FACTOR	120 ref 8 ohms
Power Supply	
TYPE	High current, high frequency switch-mode
AC INPUT OPERATING RANGE	100-240V +/-10% 45 - 65Hz
TOTAL SYSTEM EFFICIENCY	>90% typical
MAINS CONNECTOR	1 x Neutrik Powercon™
Physical	
DIMENSIONS	(W) 482 x (H) 2U/88mm x (D) 441mm (W) 19in x (H) 2U/3.5in x (D) 17.4in incl handles and optional rear support
WEIGHT	8kg (17.6lbs)

VIA5004

General	
TYPE	Four-channel Class D amplifier
POWER OUTPUT*	4 x 1250W into 2 ohms 4 x 800W into 4 ohms 4 x 450W into 8 ohms 2 x 2500W bridged into 4 ohms
COOLING	
Vari-speed fans, front-to-back airflow	
MAXIMUM AMBIENT TEMPERATURE	40°C (105°F)
Audio Inputs/Outputs	
ANALOGUE IN/LINK (4 CHANNELS)	4 x female, 4 x male Neutrik™ XLR
ANALOGUE INPUT IMPEDANCE	10KΩ balanced
MAXIMUM ANALOGUE INPUT LEVEL	+20dBu
AMPLIFIER OUTPUTS	4 x Neutrik Speakon™ NL4
Audio Performance	
OUTPUT NOISE	-113dBA, referenced to max output (22kHz bandwidth)
FREQUENCY RESPONSE	<10Hz - >20kHz +/- 0.25dB
TOTAL HARMONIC DISTORTION	<0.05% typical @ 1kHz, -3dB output (22kHz bandwidth)
SLEW RATE	>80V per microsecond
DAMPING FACTOR	120 ref 8 ohms
Power Supplies	
TYPE	2 x high current, high frequency switch-mode
AC INPUT OPERATING RANGE	100-240V +/-10% 45 - 65Hz
TOTAL SYSTEM EFFICIENCY	>90% typical
MAINS CONNECTOR	1 x Neutrik Powercon™
Physical	
DIMENSIONS	(W) 482 x (H) 2U/88mm x (D) 441mm (W) 19in x (H) 2U/3.5in x (D) 17.4in incl handles and optional rear support
WEIGHT	10kg (22lbs)

Current Draw and Thermal Dissipation

VIA2004

Level	Load (Ω)	Rated power (W)	Output power	Input power	Current draw (amps)		Thermal dissipation		
					230V	115V	Watt	BTU/h	Kcal/h
Quiescent power – No signal			0	26	0.19	0.34	26	89	23
Pink noise (1/8 rated power)	8	4 x 250	125	179	0.96	1.91	54	184	46
	4	4 x 500	250	342	1.71	3.43	92	313	79
Pink noise (1/4 rated power)	8	4 x 250	250	316	1.59	3.17	66	225	57
	4	4 x 500	500	628	2.96	5.92	128	438	110

VIA2502

Level	Load (Ω)	Rated power (W)	Output power	Input power	Current draw (amps)		Thermal dissipation		
					230V	115V	Watt	BTU/h	Kcal/h
Quiescent power – No signal			0	33	0.60	1.07	33	111	28
Pink noise (1/8 rated power)	8	2 x 450	112.5	165	1.04	2.07	53	180	45
	16	1 x 900 (bridged)							
	4	2 x 800	200	278	1.60	3.20	78	266	67
	8	1 x 1600 (bridged)							
	2	2 x 1250	312.5	433	2.45	4.91	121	411	104
	4	1 x 2500 (bridged)							
Pink noise (1/4 rated power)	8	2 x 450	225	289	1.66	3.33	64	218	55
	16	1 x 900 (bridged)							
	4	2 x 800	400	496	2.80	6.60	96	327	83
	8	1 x 1600 (bridged)							
	2	2 x 1250	625	763	4.25	8.50	138	471	119
	4	1 x 2500 (bridged)							

VIA5002

Level	Load (Ω)	Rated power (W)	Output power	Input power	Current draw (amps)		Thermal dissipation		
					230V	115V	Watt	BTU/h	Kcal/h
Quiescent power – No signal			0	53	1.13	2.01	53	181	46
Pink noise (1/8 rated power)	8	2 x 900	225	318	2.00	4.00	93	317	80
	4	2 x 1600	400	544	3.12	6.25	144	491	124
	2	2 x 2500	625	855	4.84	9.68	230	784	198
Pink noise (1/4 rated power)	8	2 x 900	450	567	3.25	6.49	117	399	101
	4	2 x 1600	800	981	5.53	11.06	181	617	156
	2	2 x 2500	1250	1514	8.44	16.88	264	900	227

VIA5004

Level	Load (Ω)	Rated power (W)	Output power	Input power	Current draw (amps)		Thermal dissipation		
					230V	115V	Watt	BTU/h	Kcal/h
Quiescent power – No signal			0	33	0.60	1.07	33	111	28
Pink noise (1/8 rated power)	8	4 x 450	225	318	2.00	4.00	93	317	80
	16	2 x 900 (bridged)							
	4	4 x 800	400	544	3.12	6.25	144	491	124
	8	2 x 1600 (bridged)							
	2	4 x 1250	625	855	4.84	9.68	230	784	198
	4	2 x 2500 (bridged)							
Pink noise (1/4 rated power)	8	4 x 450	450	567	3.25	6.49	117	399	101
	16	2 x 900 (bridged)							
	4	4 x 800	800	981	5.53	11.06	181	617	156
	8	2 x 1600 (bridged)							
	2	4 x 1250	1250	1514	8.44	16.88	264	900	227
	4	1 x 2500 (bridged)							

Technical Drawings

VIA2004

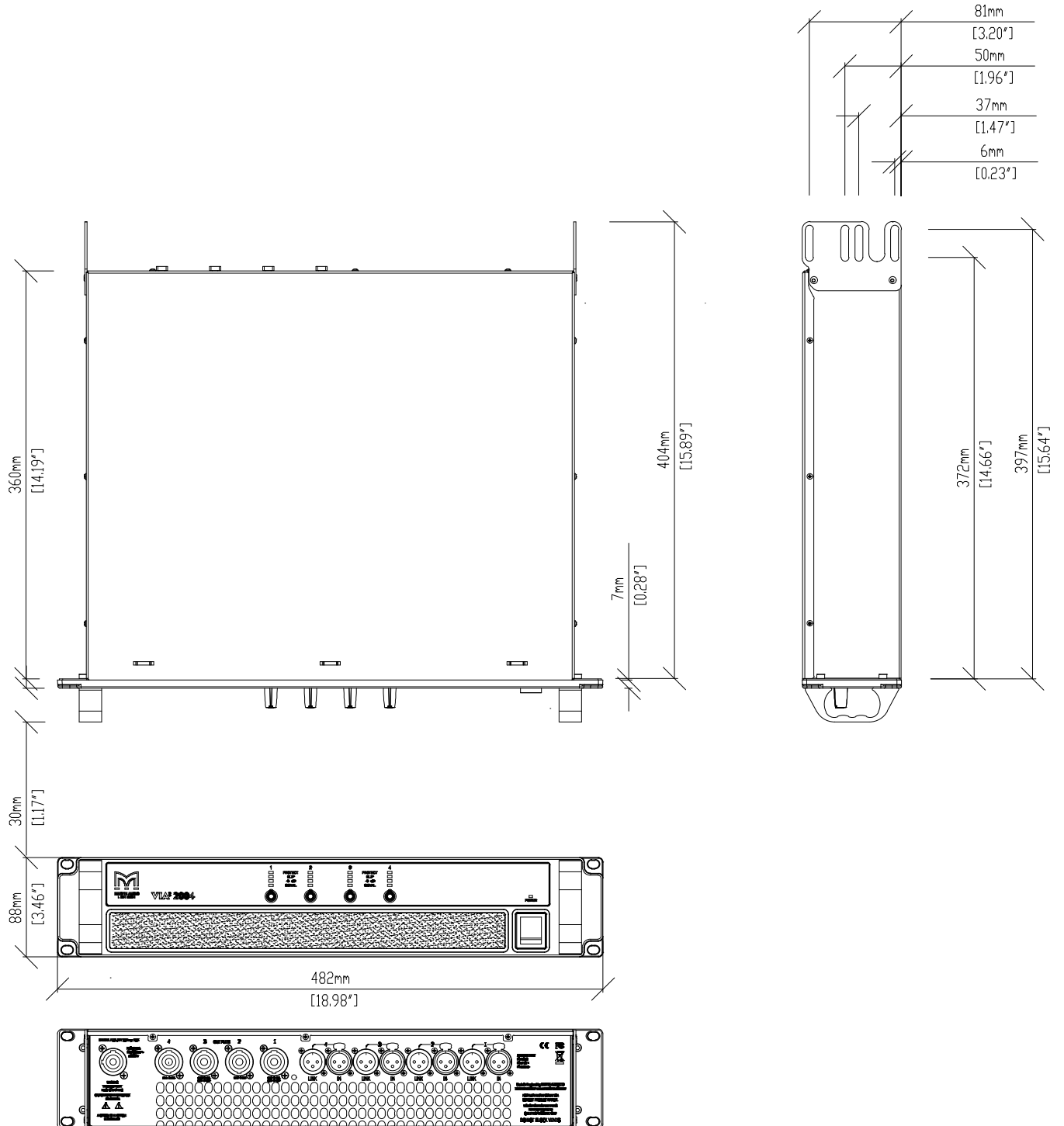

VIA2502

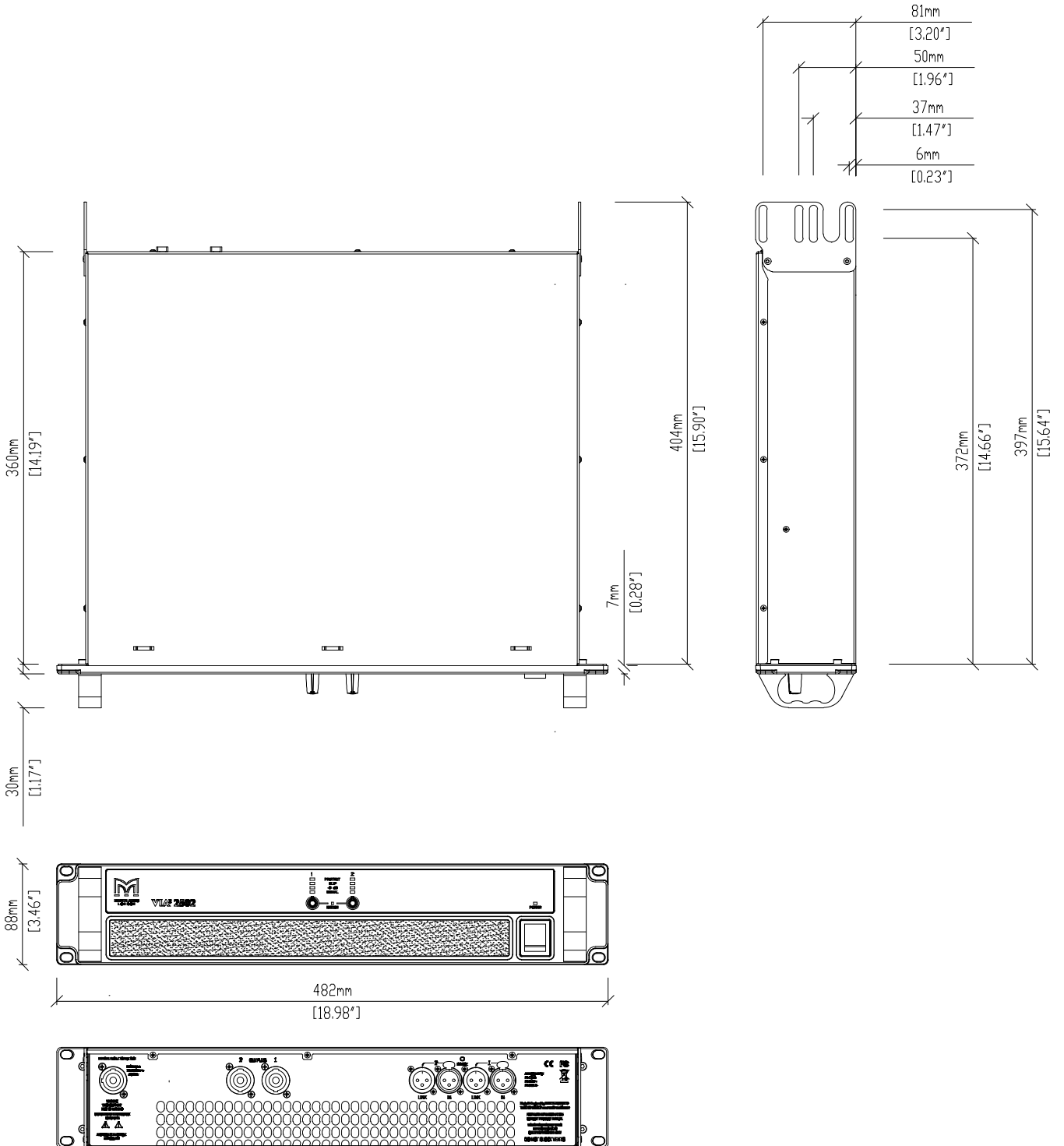

VIA5002

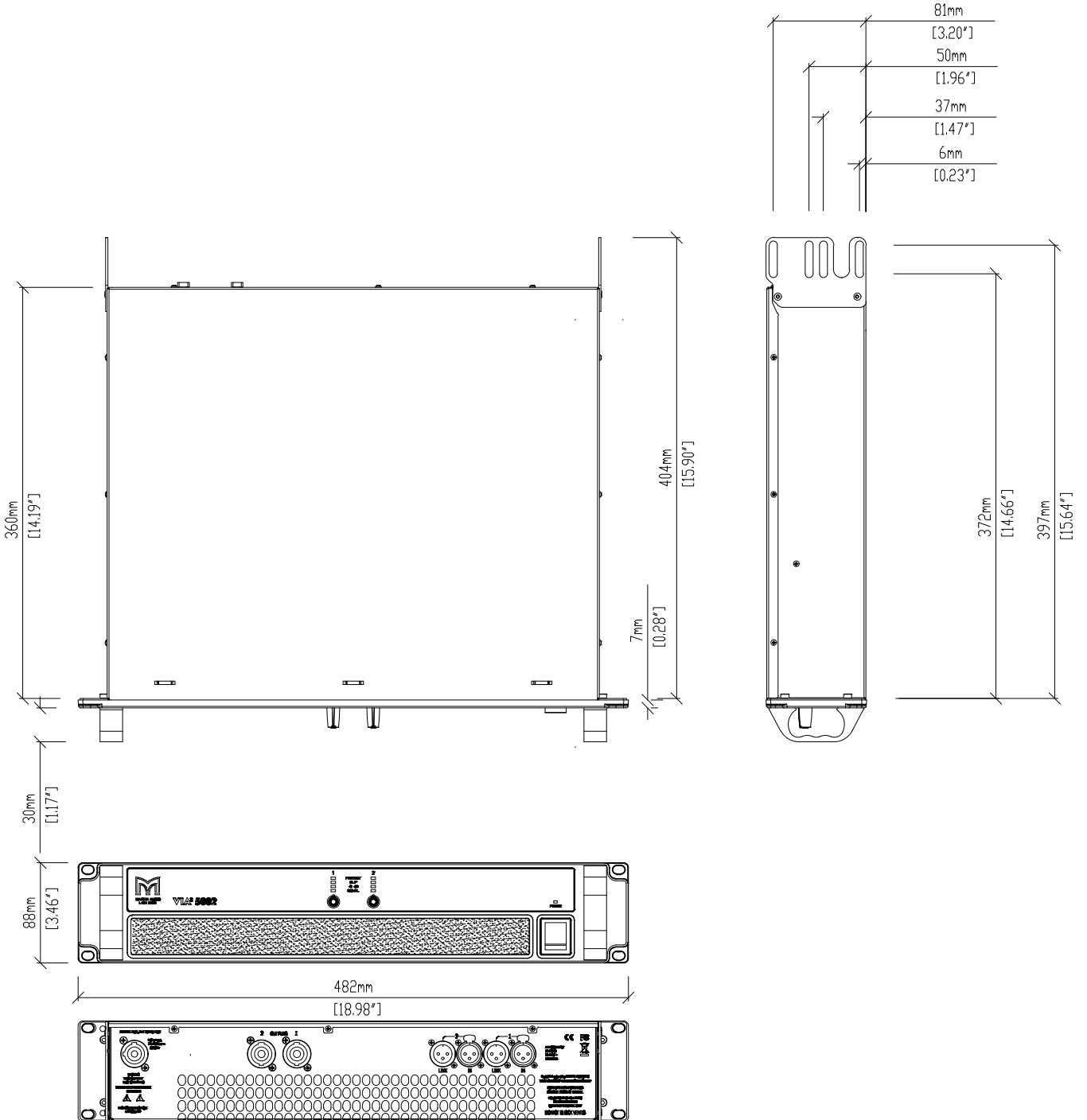

VIA5004

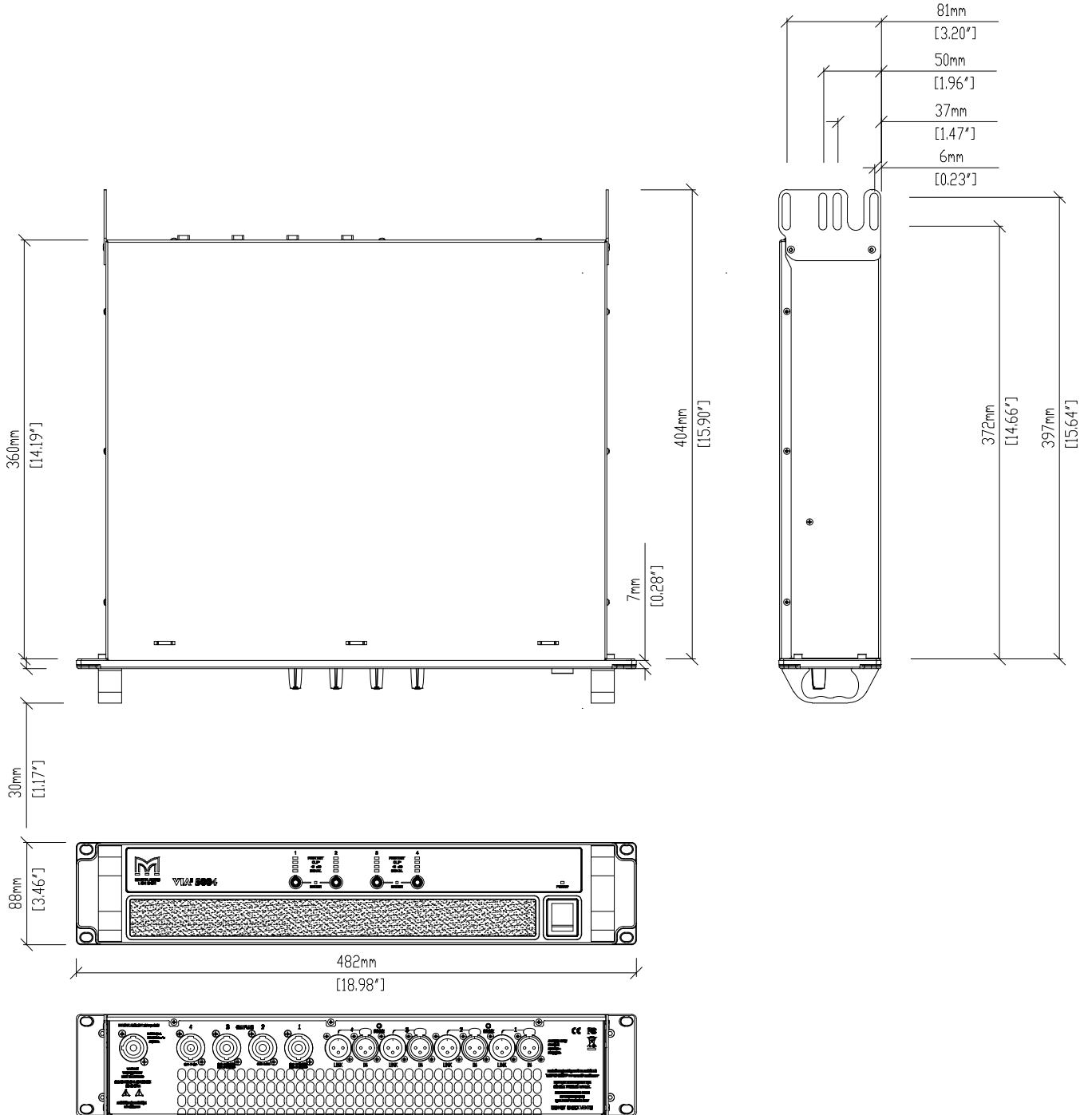

Warranty

Warranty Statement

Martin Audio VIA amplifiers are warranted against manufacturing defects in materials or craftsmanship over a period of one year from the date of original purchase.

During the warranty period Martin Audio will, at its discretion, either repair or replace products which prove to be defective provided that the product is returned in its original packaging, shipping prepaid, to an authorised Martin Audio service agent or distributor.

Martin Audio Ltd. cannot be held responsible for defects caused by unauthorised modifications, improper use, negligence, exposure to inclement weather conditions, act of God or accident, or any use of this product that is not in accordance with the instructions provided by Martin Audio. Martin Audio is not liable for consequential damages.

This warranty is exclusive, and no other warranty is expressed or implied. This warranty does not affect your statutory rights.

Martin Audio Limited

Century Point

Halifax Road

Cressex Business Park

High Wycombe

Buckinghamshire

HP12 3SL

England

FOR SALES ENQUIRIES:

UK

Telephone: +44 (0)1494 535312

E-mail: info@martin-audio.com

NORTH AMERICA

Telephone: 323 381 5310

www.martin-audio.com

All information is Copyright © 2020 Martin Audio Ltd.

Martin Audio, the Martin Audio logo and Hybrid are registered trademarks of Martin Audio Ltd. in the United Kingdom, United States and other countries; all other Martin Audio trademarks are the property of Martin Audio Ltd.

